

客戶名稱 CUSTOMERS:			
日期 DATE:			
產品名稱 PRODUCT:	Non-Inductive Wire Wound Resistors (NKNP Series) 無感型繞線電阻器		
物料代號 PART NO.:	Customer		版本
	Queen Mao	NKNP□□□□-□□□□-□□□□R□	REV.: V10.12

規格承認書 APPROVAL SHEET



客戶承認簽印 CUSTOMER APPROVED BY	核准 APPROVE	主管 CHIEF	承辦 RESPONSIBLE
APPROVED NO.:	ECN.:	/	/
MODEL:		/	/
CUSTOMER P/N:		/	/



昆 貿 電 子 股 份 有 限 公 司
QUEEN MAO ELECTRONIC CO., LTD.

22178 新 北 市 汐 止 區 大 安 街 56 巷 35 號
 No. 35, LANE 56, DA'AN STREET, XIZHI DISTRICT, NEW TAIPEI CITY 22178, TAIWAN (R.O.C.)

TEL: 886-2-8648-5566 FAX: 886-2-8648-0538

E-mail: service@queenmao.com.tw

URL: <http://www.queenmao.com.tw>



1. 一般事項 General

1.1 適用範圍 Scope

本承認書適用於[無感型繞線電阻器]。
 This specification covers Non-Inductive Wire Wound Resistors.

1.2 品質 Quality

本電阻器的製造係經高品質管理程序，並具有高信賴性的品質保證，且符合 RoHS 和無鹵要求。
 The resistor is manufactured by highly quality-controlled process and guaranteed high reliability, it meets RoHS & Halogen-Free requirement.

1.3 標準試驗狀態 Standard measuring conditions

溫度 20±2°C、濕度 65±5%。
 但在溫度 5~35°C、濕度 45~85%之情況下，仍可給予判定。
 Temperature 20±2°C, Humidity 65±5%.
 Being no doubt about the judgment, measurements can be made within the following Temperature 5~35°C, Humidity 45~85%.

1.4 形名 (例) Type designation (example)

依使用種類、額定電力、形狀、公稱電阻值、電阻值容許差而區別，其構造如下：
 The type designation shall be in the following form and as specified.

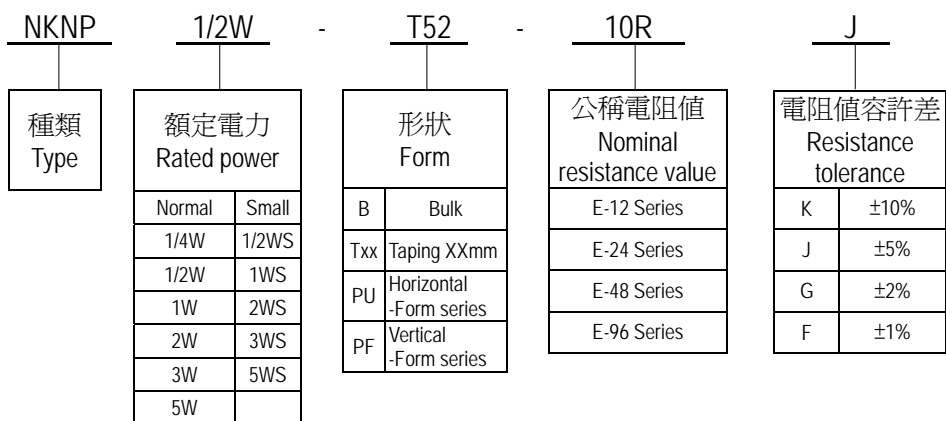

Examples

記號 Code	電阻值 Resistance value
0.12R	0.12Ω
120R	120Ω
1.2KR	1.2KΩ



1.5 額定電力 Rated power

額定電力係適應在周圍溫度 70°C 可以連續負載的最大電力，如表-1；但周圍溫度如超過 70°C 時之額定電力則依圖一的電力輕減曲線實施。

Rated power is maximum power which can be continuously loaded at specified ambient temperature 70°C, however when the ambient temperature exceeds 70°C, rated power should be determined from the derating curve of Fig.1.

表-1 Table-1

種類 Type	額定 電力 Rated power	耐電壓 Dielectric withstanding voltage	電阻值範圍 Resistance range	使用溫度範圍 Operating temperature range
Normal size	NKNP1/4W	0.25W	250V	-55°C ~ 155°C
	NKNP1/2W	0.5W	350V	
	NKNP1W	1W	500V	
	NKNP2W	2W	500V	
	NKNP3W	3W	500V	
	NKNP5W	5W	500V	
Small size	NKNP1/2WS	0.5W	250V	
	NKNP1WS	1W	350V	
	NKNP2WS	2W	500V	
	NKNP3WS	3W	500V	
	NKNP5WS	5W	500V	

Note: 1. Special specification can be constructed on request, except the resistance value is less than 0.22Ω at 1% tolerance.
2. Please refer the material list in the item 2.2.

圖一 電力輕減曲線 Figure 1 Power derating curve

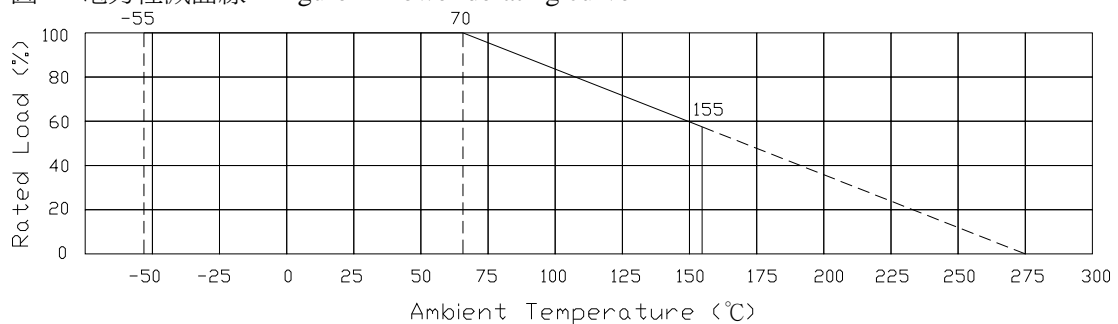



1.6 額定電壓 Rated voltage

額定電壓係指對應於額定電力的直流或交流（商用頻率之有效值）的電壓，由下式求得。

The rated voltage shall be the D.C. or A.C. (R.M.S. at power frequency) voltage which corresponds the rated power and the value of which is calculated from the formula below.

$$E = \sqrt{P \cdot R}$$

Where E：額定電壓 Rated voltage (V)
P：額定電力 Rated power (W)
R：公稱電阻值 Norminal resistance (Ω)

1.7 公稱電阻值 Nominal resistance values

公稱電阻值係按表-2 之數乘以 10^n (n 為整數) 之數值，其單位為歐姆(Ω)。公稱電阻值之範圍則按表-1 所示。

The nominal resistance values shall be the numerical values given in Table-2 multiplied by 10^n (n is an integer) in the unit of ohm(Ω).

The minimum resistance and maximum resistance shall be as given in Table-1.

表-2 電阻值有效數字的標準 Table-2 Standard nominal resistance values

系列名 Name of series	標準公稱電阻值 (為有效數字，單位省略) Standard nominal resistance values (significant figures with the unit omitted)
E-6	1.0, 1.5, 2.2, 3.3, 4.7, 6.8
E-12	1.0, 1.2, 1.5, 1.8, 2.2, 2.7, 3.3, 3.9, 4.7, 5.6, 6.8, 8.2
E-24	1.0, 1.1, 1.2, 1.3, 1.5, 1.6, 1.8, 2.0, 2.2, 2.4, 2.7, 3.0, 3.3, 3.6, 3.9, 4.3, 4.7, 5.1, 5.6, 6.2, 6.8, 7.5, 8.2, 9.1
E-48	1.00, 1.05, 1.10, 1.15, 1.21, 1.27, 1.33, 1.40, 1.47, 1.54, 1.62, 1.69, 1.78, 1.87, 1.96, 2.05, 2.15, 2.26, 2.37, 2.49, 2.61, 2.74, 2.87, 3.01, 3.16, 3.32, 3.48, 3.65, 3.83, 4.02, 4.22, 4.42, 4.64, 4.87, 5.11, 5.36, 5.62, 5.90, 6.19, 6.49, 6.81, 7.15, 7.50, 7.87, 8.25, 8.66, 9.09, 9.53
E-96	1.00, 1.02, 1.05, 1.07, 1.10, 1.13, 1.15, 1.18, 1.21, 1.24, 1.27, 1.30, 1.33, 1.37, 1.40, 1.43, 1.47, 1.50, 1.54, 1.58, 1.62, 1.65, 1.69, 1.74, 1.78, 1.82, 1.87, 1.91, 1.96, 2.00, 2.05, 2.10, 2.15, 2.21, 2.26, 2.32, 2.37, 2.43, 2.49, 2.55, 2.61, 2.67, 2.74, 2.80, 2.87, 2.94, 3.01, 3.09, 3.16, 3.24, 3.32, 3.40, 3.48, 3.57, 3.65, 3.74, 3.83, 3.92, 4.02, 4.12, 4.22, 4.32, 4.42, 4.53, 4.64, 4.75, 4.87, 4.99, 5.11, 5.23, 5.36, 5.49, 5.62, 5.76, 5.90, 6.04, 6.19, 6.34, 6.49, 6.65, 6.81, 6.98, 7.15, 7.32, 7.50, 7.68, 7.87, 8.06, 8.25, 8.45, 8.66, 8.87, 9.09, 9.31, 9.53, 9.76



2. 構造 Construction

2.1 外形寸法 External dimensions

參照本仕様書の「5. 外形寸法」。

The dimensions shall be satisfied with 「5. External dimensions」.

2.2 構造圖 Structure diagram

NKNP 系列之繞線電阻器係按下表的材料而構成：

The construction of resistor (NKNP series) shall be as follows：

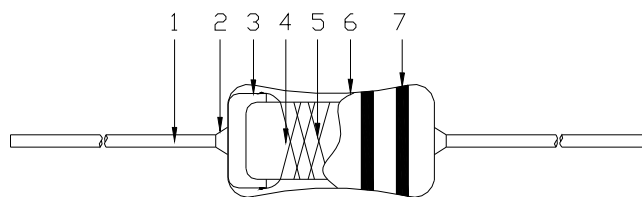

號碼 No.	構造名稱 Item	內容 Material
1	導線 Lead wire	焊錫或鍍錫的軟銅線。 Soldered or tinned annealed copper wire.
2	連接 Connection	導線對鐵帽須以電氣熔接。 The lead wire, which is plated with solder, shall be mounted to the caps by welding process.
3	端子 Terminal	鐵帽。 Tinned iron cap.
4	基體磁器 Ceramic core	使用高含鋁量的瓷器棒。 High alumina ceramic is used.
5	電阻體 Resistance element	電阻體的成份係使用具耐熱性之鎳合金抵抗線； 超低電感量(1uH 以下)。 The resistor element consists of heat resistant wire of nickel alloy; Very low inductance. (less than 1uH)
6	絕緣塗裝 Insulation coating	使用矽樹脂塗料。符合 UL94 V-0 不燃性規定。 Silicone resin is used. Accord with UL94 V-0 nonflammable specification.
7	表示 Indication	色碼。 Color code.



2.3 鐵帽端子 Terminal caps

鐵帽端子須確實地連接(電氣的及機械的)於電阻體上。

The caps shall be securely connected with the resistor element electrically and mechanically.

2.4 塗裝 Painting

2.4.1 本體必須依照仕様書之規定以絕緣塗料絕緣之。

Coating in accordance with specification insulates the body.

2.4.2 塗裝時 1/8W(1/4WS)的電阻其焊點和端子線可允許被塗料覆蓋的總長為 C=3.4mm(Max.)，1/4W 以上(1/2WS 以上) 的電阻其焊點和端子線可允許被塗料覆蓋為 t=1.0mm(Max.)，而端面、焊點和端子線可允許不被塗料覆蓋，端面部份被塗料覆蓋的限定值為 1/2D。

The 1/8W(1/4WS) resistors, welding point and Lead wire is permissible to be covered t=3.4mm(Max.), for over 1/4W(over 1/2WS) resistors, welding point and Lead wire is permissible to be covered t=1.0mm(Max.).

But welding point, terminal and lead wire, is permissible to be exposed without the outer coated cover. The extent should be within 1/2 of the arc angle.

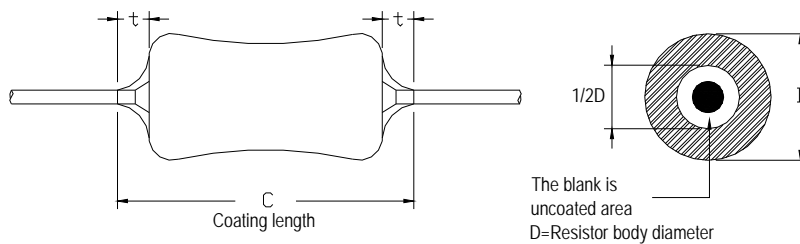

2.5 外裝色澤 Resistor body color

表-3 Table-3

種類 Type	顏色 Color	種類 Type	顏色 Color
普通型 Normal Size	灰色 Grey	小型化 Small Size	草綠色 Deep Green

2.6 表示 Indication

參照本仕様書的「4. 表示」。

The indication shall be satisfied with 「4. Indication」.



3. 特性 Characteristics

表-4 Table-4

項目 Item	規格值 Performance	試驗方法 (依據 JIS C 5202) Test methods (Conform to JIS C 5202)
溫度係數 Temperature coefficient	±300PPM/°C 以內。 within ±300PPM/°C	5.2 項參照 Comply with 5.2 $\frac{R_1 - R_0}{R_0(T_1 - T_0)} \times 10^6 \text{ (PPM/°C)}$ R ₀ : 室溫(T ₀)所測量之電阻值。 R ₁ : 室溫+100°C (T ₁)後所測量之電阻值。 R ₀ : Resistance value at room temp. (T ₀). R ₁ : Resistance value at room temp. plus 100°C (T ₁).
短時間過負荷 Short time overload	±(2%+0.05Ω)以內。 不得有機械的損傷。 within ±(2%+0.05Ω) No evidence of mechanical damage.	5.5 項參照 Comply with 5.5 額定電力的 10 倍, 5 秒。 10 times of rated wattage for 5 seconds
絕緣抵抗 Insulation resistance	10 ³ MΩ 以上。 10 ³ MΩ or more	5.6 項參照 Comply with 5.6 置於 V 型槽方法。 施加直流電壓 500V 60 秒。 V-block method Resistor shall be tested at DC 500V for 60 seconds.
耐電壓 Dielectric withstanding voltage	無電弧放電、燒損及絕緣破壞等異狀。 No evidence of flashover mechanical damage, arcing or insulation breakdown.	5.7 項參照 Comply with 5.7 常壓, 置於 V 型槽方法。 施加個別規定之交流電壓 60 秒。(見表-1) Constant pressure, V-block method Resistor shall be tested at AC potential respectively for 60 seconds.(See table-1)
斷續過負荷 Pulse overload	±(2%+0.05Ω)以內。 within ±(2%+0.05Ω)	5.8 項參照 Comply with 5.8 額定電壓 X 4 倍, 10000 回(1 秒 ON, 25 秒 OFF)。 Rated voltage X 4 times, 10000 cyc.(1s ON, 25s OFF)
端子強度 Terminal strength	端子不得斷裂及鬆弛。 No evidence of mechanical damage.	6.1 項參照 Comply with 6.1 引張強度: 25N(2.5Kgf), 保持 10 秒。 Tensile strength: 25N(2.5kgf), for 10 seconds. 扭轉強度: 360°交互迴轉 5 回。 Torsional strength: Rotated through 360°, 5 rotations.



項目 Item	規格值 Performance	試驗方法 (依據 JIS C 5202) Test methods (Conform to JIS C 5202)
焊錫耐熱性 Resistance to soldering heat	±(2%+0.05Ω)以內。 不得有機械的損傷。 within ±(2%+0.05Ω) No evidence of mechanical damage.	6.4 項參照 Comply with 6.4 350±10°C, 3±0.5 秒 或 260±5°C, 10±1 秒, 試驗後放置 3 小時。 350±10°C, 3±0.5s or 260±5°C, 10±1s, After test leave for 3h.
焊錫附著性 Solderability	導線至少 95%以上新錫覆蓋。 Covered with new solder by 95% at least.	6.5 項參照 Comply with 6.5 焊錫溫度：245±5°C。 浸錫時間：5±0.5 秒。 Test temperature of solder: 245±5°C Dipping time in solder: 5±0.5s
耐溶劑性 Resistance to solvent	塗裝及色碼不得脫落。 No deterioration of protective coating and markings.	6.9 項參照 Comply with 6.9 放入異丙醇溶劑之超音波機內，保持 3 分鐘。 Specimens shall be immersed in a bath of isopropyl alcohol completely for 3 minutes with ultrasonic.
溫度循環 Temperature cycle	±(2%+0.05Ω)以內。 不得有機械的損傷。 within ±(2%+0.05Ω) No evidence of mechanical damage.	7.4 項參照 Comply with 7.4 低溫側：-55±3°C：30 分鐘, 室溫：2~3 分鐘 高溫側：+155±2°C：30 分鐘, 室溫：2~3 分鐘 5 回 Low side：-55±3°C：30min, Room temp.：2 to 3min High side：+155±2°C：30min, Room temp.：2 to 3min 5 cycles
耐濕負荷壽命 Load life in humidity	±(5%+0.05Ω)以內。 within ±(5%+0.05Ω)	7.9 項參照 Comply with 7.9 40±2°C, 濕度 90~95%, 1000 小時 定格電壓(90 分鐘 ON, 30 分鐘 OFF) 40±2°C, 90 to 95%RH, 1000h Rated voltage (90 min ON, 30 min OFF)
負荷壽命 Load life	±(5%+0.05Ω)以內。 within ±(5%+0.05Ω)	7.10 項參照 Comply with 7.10 70±3°C, 1000 小時 定格電壓(90 分鐘 ON, 30 分鐘 OFF) 70±3°C, 1000h Rated voltage (90 min ON, 30 min OFF)
不燃性 Incombustibility	沒有出現火災。 No evidence of flame.	7.12 項參照 Comply with 7.12 加 4 倍,8 倍,16 倍,32 倍額定電力 AC 電壓 1 分鐘 至斷線(或相對試驗前電阻值之變化率超過 100 倍)為止。 但負荷電壓不超過最高使用電壓的 4 倍 AC voltage of 4, 8, 16 and 32 times the power rating shall be applied for 1 min. each time until disconnection occurs(or the change rate is 100 times more than the one before test.). However the applied voltage shall not exceed the value of 4 times of the maximum operating voltage.



4. 表示 Indication
色碼 Color Code

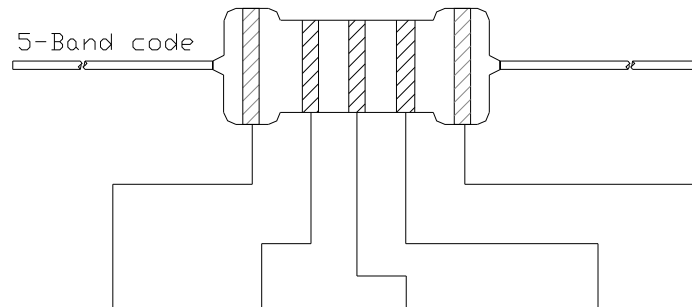

顏色 Color	第1數字 1st figure	第2數字 2nd figure	倍 率 Multiplier	誤差率 Tolerance	記 號 Symbol
黑 Black	0	0	10^0		KNP
棕 Brown	1	1	10^1	±1% (F)	
紅 Red	2	2	10^2	±2% (G)	
橙 Orange	3	3	10^3		
黃 Yellow	4	4	10^4		
綠 Green	5	5	10^5	±0.5% (D)	NKNP
藍 Blue	6	6	10^6	±0.25%(C)	
紫 Violet	7	7	10^7	±0.1% (B)	
灰 Gray	8	8		±0.05%(A)	
白 White	9	9	10^{-3}		
金 Gold			10^{-1}	±5% (J)	
銀 Silver			10^{-2}	±10% (K)	
無 Plain				±20% (M)	



5. 外形寸法 External dimensions

5.1 散裝 B 形與 臥式 PU 形系列 B type (Straight) & PU-Form series (Horizontal Forming)

B Type

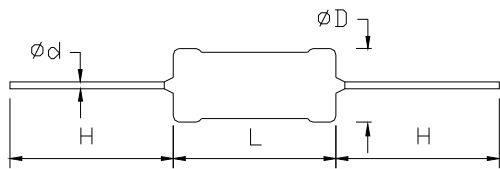

PU Type

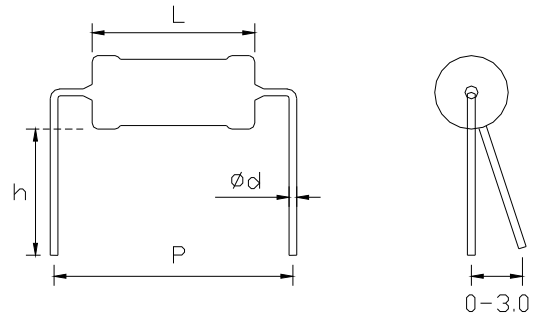

單位：mm
Unit：mm

種類 Type		尺寸 Dimensions					
普通型 Normal Size	小型化 Small Size	L	ϕD	ϕd	H	P	h
NKNP1/4W	NKNP1/2WS	6.5±0.5	2.3±0.3	0.50±0.05	28.0±3.0	10.0±1.0	3.5±0.5
NKNP1/2W	NKNP1WS	9.0±1.0	3.2±0.5	0.60±0.10	28.0±3.0	12.5±1.0	3.5±0.5
NKNP1W	NKNP2WS	12.0±1.0	4.5±0.5	0.65±0.10	32.0±3.0	15.0±1.0	3.5±0.5
NKNP2W	NKNP3WS	15.5±1.0	5.0±1.0	0.70±0.10	35.0±3.0	20.0±1.0	3.5±0.5
NKNP3W	NKNP5WS	17.5±1.0	6.5±1.0	0.70±0.10	35.0±3.0	25.0±1.0	3.5±0.5
NKNP5W		24.5±1.0	9.0±1.0	0.70±0.10	32.0±3.0	30.0±1.0	3.5±0.5



PUK Type (Kinked Forming)

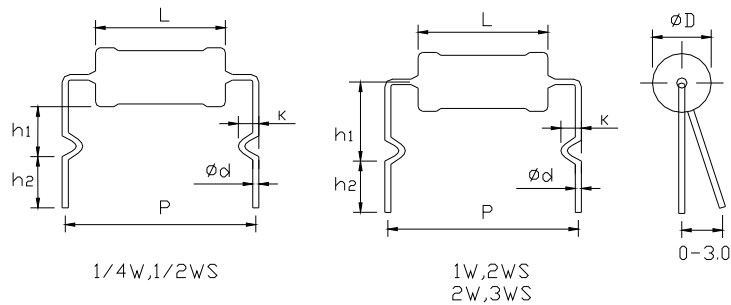

單位：mm
Unit：mm

種類 Type		尺寸 Dimensions						
普通型 Normal Size	小型化 Small Size	L	ϕD	ϕd	P	h_1	h_2	K
NKNP1/4W	NKNP1/2WS	6.5±0.5	2.3±0.3	0.50±0.05	10±0.5	5.0±1.0	3.5±0.5	2.0±0.5
NKNP1W	NKNP2WS	12.0±1.0	4.5±0.5	0.65±0.10	15.0±1.0	5.0±1.0	2.7-3.6	2.0±0.5
NKNP2W	NKNP3WS	15.5±1.0	5.0±1.0	0.70±0.10	22.0±1.0	5.0±1.0	2.7-3.6	2.0±0.5

PUG Type (Free-standing Forming)

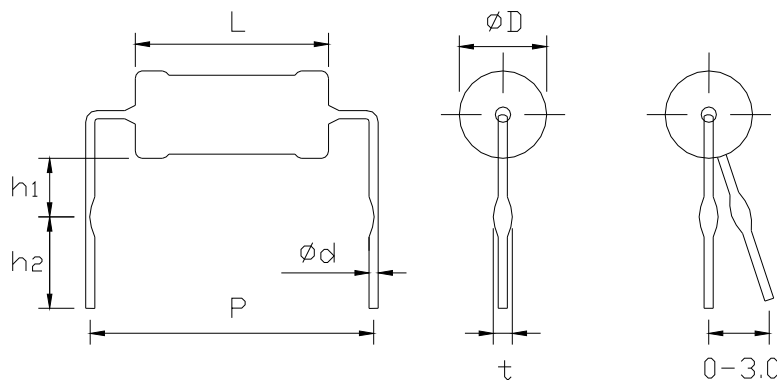

單位：mm
Unit：mm

種類 Type		尺寸 Dimensions						
普通型 Normal Size	小型化 Small Size	L	ϕD	ϕd	P	h_1	h_2	t
NKNP1/2W	NKNP1WS	9.0±1.0	3.2±0.5	0.70±0.10	12.5±1.0	6.0±2.0	4.5±0.5	1.4±0.2
NKNP1W	NKNP2WS	12.0±1.0	4.5±0.5	0.70±0.10	15.0±1.0	6.0±2.0	4.5±0.5	1.4±0.2
NKNP2W	NKNP3WS	15.5±1.0	5.0±1.0	0.70±0.10	20.0±1.0	10.0±2.0	4.5±0.5	1.4±0.2
NKNP3W	NKNP5WS	17.5±1.0	6.5±1.0	0.70±0.10	25.0±1.0	10.0±2.0	4.5±0.5	1.4±0.2
NKNP5W		24.5±1.0	9.0±1.0	0.70±0.10	30.0±1.0	12.0±2.0	4.5±0.5	1.4±0.2



5.2 立式 PF 形系列 PF-Form series (Vertical Forming)

PF Type

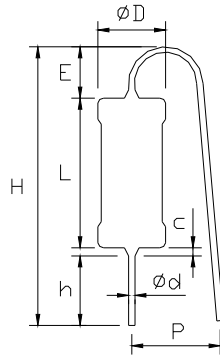

Double Kinked Forming PFKK Type

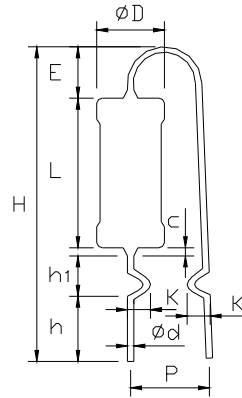

Single Kinked Forming PFK1 Type

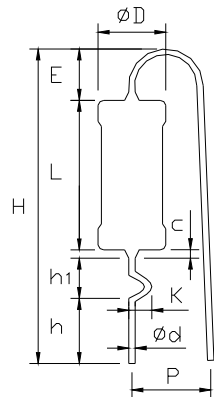

Single Kinked Forming PFK2 Type

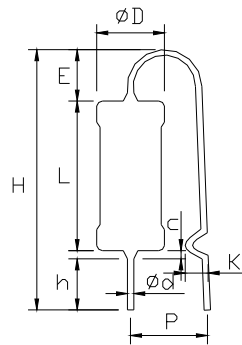

單位：mm
Unit：mm

種類 Type		尺寸 Dimensions								
普通型 Normal Size	小型化 Small Size	L	ϕD	ϕd	P	h	h_1	H	E	K
NKNP1/4W	NKNP1/2WS	6.5±0.5	2.3±0.3	0.50±0.05	5~7	3.5±0.5	5.0±2.0	18 Max.	2.5±1.0	2.0±0.5
NKNP1/2W	NKNP1WS	9.0±1.0	3.2±0.5	0.60±0.10	5~7	3.5±0.5	5.0±2.0	21 Max.	2.5±1.0	2.0±0.5
NKNP1W	NKNP2WS	12.0±1.0	4.5±0.5	0.65±0.10	5~9	3.5±0.5	5.0±2.0	24 Max.	2.5±1.0	2.0±0.5
NKNP2W	NKNP3WS	15.5±1.0	5.0±1.0	0.70±0.10	5~9	3.5±0.5	5.0±2.0	28 Max.	2.5±1.0	2.0±0.5
NKNP3W	NKNP5WS	17.5±1.0	6.5±1.0	0.70±0.10	5~9	3.5±0.5	5.0±2.0	30 Max.	2.5±1.0	2.0±0.5
NKNP5W		24.5±1.0	9.0±1.0	0.70±0.10	5~9	3.5±0.5	5.0±2.0	35 Max.	2.5±1.0	2.0±0.5

Remarks: c = 1.0 max. , c+h=3.7±0.5



5.3 帶裝 Axial Lead Taping
Txx Type

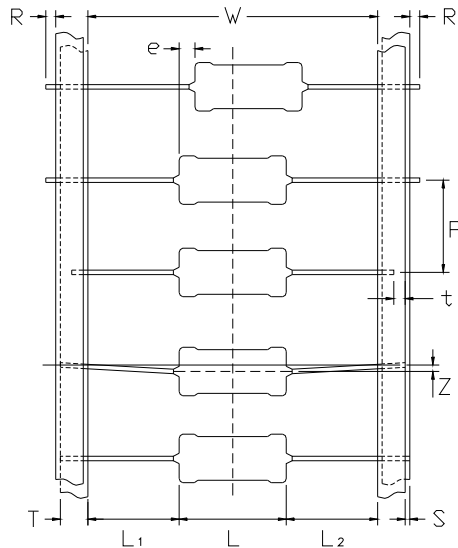

單位：mm
Unit：mm

種類 Type		帶狀 Taping	尺寸 Dimensions									
普通型 Normal Size	小型化 Small Size		L	W	P	L1-L2 Max.	T	Z Max.	R Max	t Max	e Max	S Max
NKNP1/4W	NKNP1/2WS	T52	6.5±0.5	52 ^{+1.5} ₋₀	5±0.3	1.0	6±0.5	0.8	0	2.5	0.5	0.5
NKNP1/2W	NKNP1WS	T52	9.0±1.0	52 ^{+1.5} ₋₀	5±0.3	1.0	6±0.5	0.8	0	2.5	0.5	0.5
NKNP1W	NKNP2WS	T52	12.0±1.0	52 ^{+1.5} ₋₀	5±0.5	1.0	6±0.5	0.8	0	2.5	0.5	0.5
		*T63	12.0±1.0	63±1.5	5±0.5	1.0	6±0.5	1.2	1.0	2.5	0.5	0.8
		T73	12.0±1.0	73±1.5	5±0.5	1.0	6±0.5	1.2	1.0	2.5	0.5	0.8
NKNP2W	NKNP3WS	T63	15.5±1.0	63±1.5	10±0.5	1.0	6±0.5	1.2	1.0	2.5	0.5	0.8
		*T73	15.5±1.0	73±1.5	10±0.5	1.0	6±0.5	1.2	1.0	2.5	0.5	0.8
NKNP3W	NKNP5WS	T83	15.5±1.0	83±1.5	10±0.5	1.0	6±0.5	1.2	1.0	2.5	0.5	0.8
		T73	17.5±1.0	73±1.5	10±0.5	1.0	6±0.5	1.2	1.0	2.5	0.5	0.8
NKNP5W		T83	17.5±1.0	83±1.5	10±0.5	1.0	6±0.5	1.2	1.0	2.5	0.5	0.8
		T83	24.5±1.0	83±1.5	10±0.5	1.0	6±0.5	1.2	1.0	2.5	0.5	0.8

Remarks: Marked "*" means standard taping dimensions, standard for 3W, 5WS and 5W is bulk packing (B Type).



6. 包裝 Package

6.1 散裝品包裝 Bulk in box packing

6.1.1 表示項目 Indication

- (1) 客戶品號 Customer Part No.
- (2) 製造品號 Manufacturer Part No.
- (3) 製造批號 Lot No.
- (4) 數量 Quantity
- (5) 製造者名 Manufacturer

6.1.2 包裝盒尺寸和數量

Packing box size and quantity

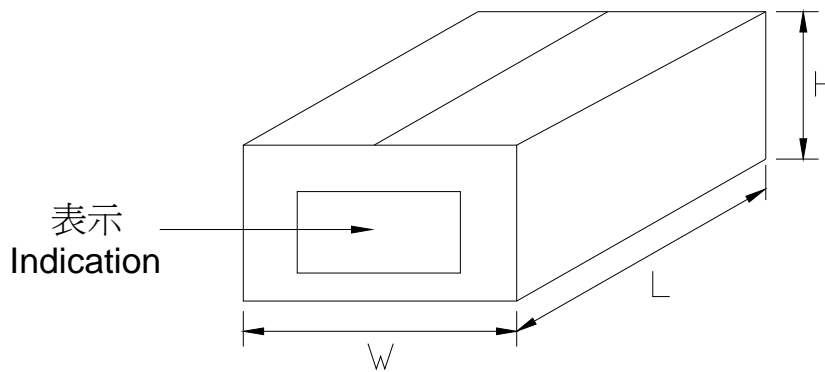

種類 Type		形狀 Form	塑膠袋包裝數 Polyethylene bag (pcs)	紙盒包裝數 Paper box (pcs)	尺寸 Dimensions (mm)		
普通型 Normal Size	小型化 Small Size				L	W	H
NKNP1/4W	NKNP1/2WS	B, PU & PF-Form series	1000	10000	238	150	70
NKNP1/2W	NKNP1WS	B	250	5000			
		PU & PF-Form series	500	5000			
NKNP1W	NKNP2WS	B	200	2000			
		PU & PF-Form series	500	3000			
NKNP2W	NKNP3WS	B	200	1000			
		PU & PF-Form series	500	2000			
NKNP3W	NKNP5WS	B	100	500			
		PU & PF-Form series	250	1000			
NKNP5W		B	50	300			
		PU & PF-Form series	100	500			



6.2 帶裝品包裝 Tape in box packing (Ammo packing)

6.2.1 表示項目 Indication

- (1) 客戶品號 Customer Part No.
- (2) 製造品號 Manufacturer Part No.
- (3) 製造批號 Lot No.
- (4) 數量 Quantity
- (5) 製造者名 Manufacturer

6.2.2 包裝盒尺寸和數量

Packing box size and quantity

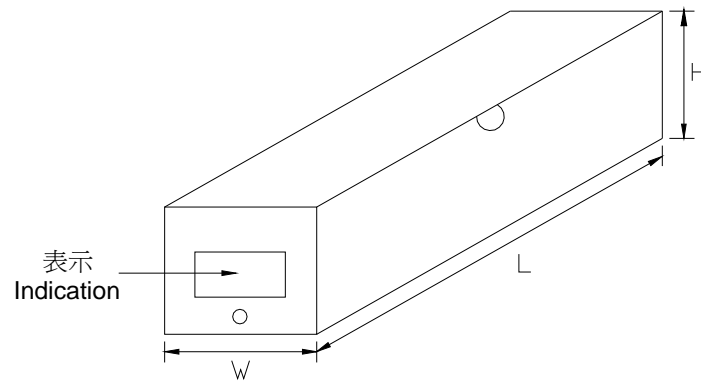

種類 Type		形狀 Form	包裝數量 Quantity (pcs)	尺寸 Dimensions (mm)		
普通型 Normal Size	小型化 Small Size			L	W	H
NKNP1/4W	NKNP1/2WS	T52	5000	258	72	111
NKNP1/2W	NKNP1WS	T52	1000	258	72	44
NKNP1W	NKNP2WS	T52	1000	258	72	43
		T63	1000	258	88	76
		T73	1000	258	96	72
NKNP2W	NKNP3WS	T73	1000	258	90	92
		T83	1000	258	105	92
NKNP3W	NKNP5WS	T73	1000	258	90	92
		T83	1000	258	105	92
NKNP5W		T73	250	258	90	92
		T83	250	258	105	92